

Power to Gas Plant Design, Modelling and Control for Precise and Flexible Methane Production

Marijo Šundrica (✉ marijo.sundrica@fer.hr)

University of Zagreb Faculty of Electrical Engineering and Computing: Sveuciliste u Zagrebu Fakultet Elektrotehnike i Racunarstva <https://orcid.org/0000-0001-6438-3141>

Mario Vašak

University of Zagreb Faculty of Electrical Engineering and Computing: Sveuciliste u Zagrebu Fakultet Elektrotehnike i Racunarstva

Joseph Maroušek

Institute of Technology and Business in České Budějovice

Tim Bieringer

Landshut University of Applied Sciences: Hochschule Landshut

Research Article

Keywords: Power to Gas, biochar, gasification, methanation, modelling, control system

DOI: <https://doi.org/10.21203/rs.3.rs-666710/v1>

License: © ⓘ This work is licensed under a Creative Commons Attribution 4.0 International License.

[Read Full License](#)

Power to Gas Plant Design, Modelling and Control for precise and flexible Methane Production

Marijo Šundrica
Laboratory for Renewable
Energy Systems
Faculty of Electrical
Engineering and
Computing
Zagreb, Croatia
marijo.sundrica@fer.hr

Mario Vašak
Laboratory for Renewable
Energy Systems
Faculty of Electrical
Engineering and
Computing
Zagreb, Croatia
mario.vasak@fer.hr

Joseph Maroušek
Institute of Technology and
Businesses in
České Budějovice
České Budějovice, Czech
Republic
15579@mail.vstecb.cz

Tim Bieringer
Technology Centre Energy
University of Applied
Sciences
Landshut, Germany
tim.bieringer@haw-landshut.de

Abstract—Production of green electrical energy and green natural gas are the main goals of zero-carbon emission policy. Power to Gas plants (P2G) can be used to overcome difficulties with increase in intermittent renewable energy production, gas shortages and organic waste management. In this paper, a design, a model, and a control system for a Power to Gas plant is proposed. To achieve a high performance P2G plant, its design is based on biochar gasification and biological methanation processes. With the given mathematical models of electrolysis, gasification and methanation, calculation of needed feedstock and energy consumption as well as calculation of produced methane becomes easy obtainable. Proposed control system enables to precisely follow frequent operation change requests due to dynamical conditions in leaned electricity or gas grids. Simulation study of the automated plant operation using Matlab/Simulink has been done. This research gives all prerequisites for optimal sizing and planning of the P2G plant operation in dynamic technical and economic conditions.

Keywords— *Power to Gas, biochar, gasification, methanation, modelling, control system*

I. INTRODUCTION

Increase in energy consumption in modern society is an everlasting process. This is especially due to rise in world population and industrialization in third countries. At the same time, due to increase in carbon dioxide (CO₂) emissions, humanity is facing climate changes. Accordingly, international policies are directed to restrictions in use of fossil fuels and support zero-carbon solutions. These are the main reasons why production from renewable energy sources is largely increasing. Intermittence of such production brings challenges to the task of balancing energy grids. Storage systems and energy sectors coupling seem to be a solution for further increase in renewable energy distribution and end-use. Power to X technologies are developed to create energy conversion links between electricity and other sectors. Specifically, for coupling with the gas sector, Power to Gas (P2G) technology offers a possibility for the use of surplus electrical energy to produce synthetic natural gas (methane - CH₄). Apart from overcoming shortages in the gas sector, P2G plants increase capacity for renewable electricity integration and could make significant contribution to waste management.

Conversion of power can be completed with production of hydrogen (H₂), which is the Power to Hydrogen (P2H) option of P2G plant. Although P2H is simpler than P2G, due to many restrictions in hydrogen usage, this option is not in the scope of this work. To enable methane production, except from H₂, P2G needs also a source of CO₂. Capturing CO₂ from air or from industrial exhaust gases needs advanced technologies. It could be also taken from biogas, but in this case, obtainable amount of CO₂ depends on biogas plant. In this research, the P2G concept with biochar as CO₂ source is considered. Its high carbon content, its transportability and its contribution in waste management makes biochar an adequate feedstock.

Production of methane from biochar and hydrogen, is to be obtained by the following processes: electrolysis, gasification and methanation. Analysis and modelling of these processes is given in the literature only partially.

As it is used in P2H option, electrolysis is well researched [1] process. H₂ is produced through electrolysis of demineralized water. Electrical energy is to be consumed during this process. It is possible to use few types [2] of electrolyzer. Classical option and the cheapest one is alkaline electrolyzer. There are drawbacks in exploitation of alkaline electrolyzer. It is limited by minimum operating power and slow starting performance. There is also ecological issue due to decomposing its electrolyte. Proton exchange membrane (PEM) electrolyzer performance is much faster and it has much wider operating range. There is also solid oxide electrolyzer (SOEC) type to be exploited commercially in the future.

During methanation process, H₂ and CO₂ react to produce CH₄. This process can be classified as catalytic or biological process [3]. In catalytic methanation, nickel is typically used as catalyst. While this is the main method in industrial processes, it is less well suited for a highly dynamic operation. Biological methanation [3] converts H₂ and CO₂ to methane using methanogenic microorganisms. It is better suited to handling intermittent operation and impurities in the gas steam.

In gasification process, oxidizer is used for production of the syngas. Due to various oxidizers, as well as different types of gasifiers, modelling of gasification is still an open research area. Specially, integration of gasification process within P2G plant model has not been done yet.

In [4], although a detailed modelling of some P2G processes (electrolysis, methanation) is done, source of CO₂ is not considered. To obtain CO₂, P2G is modelled together with Gas-fired Power Plant in [5]. Carbon capture from the Plant's exhaust gases is then used as source of CO₂. Modelling of P2G may be done using only knowledge of electrical power and gas flow [6], but this approach is restricted to a particular area. According to the given review, there is no complete model of P2G plant.

The main characteristic of the surplus energy is its intermittency. On the other hand, operation of P2G is to obey

restrictions in the gas grid sector. Namely, amount of CH_4 to be injected into the public gas grid is to be announced few hours in advance. Also, deviation of produced CH_4 from the announced value is penalized. Due to all mentioned reasons, the aim of this work is to make design of P2G that is adjusted to intermittent consumption of electrical energy as well as to intermittent production of methane. Using classical water electrolysis, hydrogen and oxygen could be stored. Oxygen is then used in a fast gasification of biochar and hydrogen is used in biological methanation process. Accordingly, adequate control system is needed for precise gas production to be achieved. Except from the amount of produced methane, using the given mathematical model consumed electrical energy and all other feedstocks can be also precisely calculated. In some future research, it will be used for optimal sizing and optimal planning of the plant operation in dynamic technical and economic conditions dictated by the grids.

Mass, heat and energy balances in the given technological conditions are used as the main methodology for the P2G process analysis.

II. PROPOSED DESIGN OF THE POWER TO GAS PLANT

Using electrical energy and demineralized water in electrolysis process, hydrogen and oxygen are produced. Firstly, hydrogen and oxygen are stored in their storage tanks. Oxygen is then used as oxidizer in the gasification process. Because gasification is oxidation with insufficient amount of oxygen supply, capacity of oxygen storage is not of significance. Temperature of the gasifier is high: between 1000 and 1600 K [7-8], and according to [9-10] gasification is assumed to be an adiabatic process. During gasification, biochar is blown by the oxygen and syngas is produced. Produced syngas goes to bubble column vessel where water gas shift (WGS) reaction occurs. Temperatures in the bubble column are much lower (400-600 K) than the temperatures in the gasifier, which enables a high conversion rate of CO into CO_2 . Note that water supply is needed to support this reaction. Finally, CO_2 and H_2 from WGS as well as H_2 from hydrogen storage go into the methanation reactor. As explained in Introduction, biological methanogenesis reaction occurs and the produced methane can be injected into the gas grid. The complete production process is depicted with a block scheme in Fig. 1.

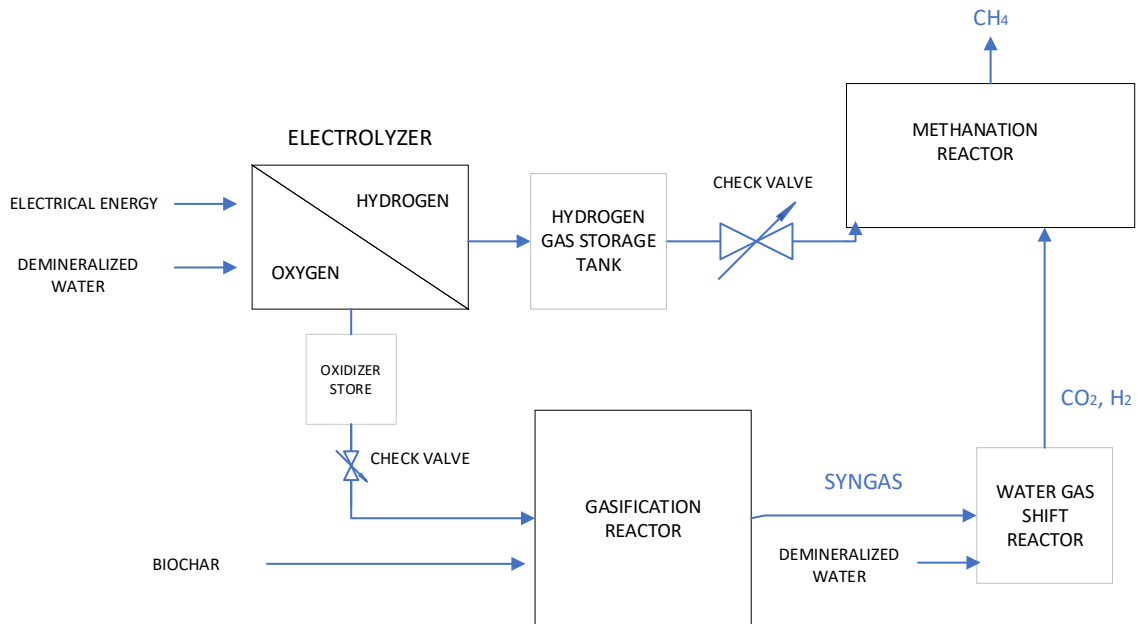

Fig. 1 Integration scheme of Power to Gas processes

III. ANALYSIS OF THE GASIFICATION PROCESS

A. Kinetics

To make an adequate kinetic model, mass balance law is used. According to the mass balance law:

$$r.c. = \text{input} - \text{output} + \text{production} - \text{consumption} \quad (1)$$

where r.c. stands for rate of change.

It is assumed that there is an infinite source of biochar in the plant's storage. Due to this, biochar will always withhold the same mass in the gasifier. Technically this is possible if there is a gravitational refilling of the consumed biochar. This means that there is a constant value of biochar mass m_{BR} in the gasifier. Biochar consumption rate, given as r_B , depends on technology details.

Using (1), equation for fuel (Biochar) in the plant's biochar storage m_B is given in (2) and equation for product (Syngas) is given in (3)

BIOCHAR:

$$r.c. \text{ bioch. plant store} = 0 - 0 + 0 - \text{consumption} \quad (2.1)$$

$$\frac{d m_B}{dt} = -\text{consumption}, \quad (2.2)$$

$$\frac{d m_B}{dt} = -m_{BR} * r_B. \quad (2.3)$$

SYNGAS:

$$r.c. \text{ syngas} = 0 - \text{output} + \text{production} - 0 \quad (3.1)$$

During gasifier operation, temperature and pressure can be assumed to be at about a constant average value. This means that the state of syngas in the gasifier is unchanged:

$$0 = 0 - \text{output} + \text{production} - 0 \quad (3.2)$$

It can be concluded that syngas "output" is the same as "production" of syngas in the gasification reactor. Produced syngas is obtained from the consumed biochar subtracted with losses (tar, soot, ash) which are included in biochar to syngas efficiency $\eta_{B \rightarrow S}$. Syngas equation can be written as:

$$\frac{d m_{SG \text{ output}}}{dt} = \eta_{B \rightarrow S} * m_{BR} * r_B \quad (3.3)$$

B. Syngas composition

Syngas composition is obtained by using the main gasification equation [11-12]:

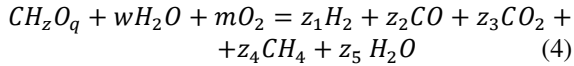

CH_zO_q - approximative formula of biomass or biochar

w - moisture per mole of biomass or biochar

m - moles of oxidizer

z_i - stoichiometric ratio factors of the "i-th" product (z_1 ,

z_2, z_3, z_4, z_5 - hydrogen, carbon monoxide, carbon dioxide, methane and water)

Except from many oxidation reactions at some temperature, these chemical reactions are assumed to achieve their equilibria:

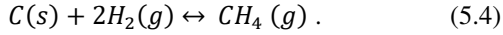
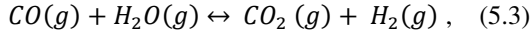
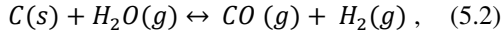
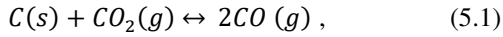

Where 'C' is carbon from biochar, and 's' and 'g' denote the solid and gas phases, respectively. Reactions (5) are well known in chemical engineering. They are: Boudouard reaction (5.1), Steam gasification (5.2), Gas shift reaction (5.3) and Methane formation (5.4).

Each reaction given in (5) has its equilibrium. Their equilibrium constants K can be expressed as functions of stoichiometric ratios of reactants and products. According to [9], only reactants and products in gas phase are considered. Respectively to reaction (5) numeration, equilibrium constants are:

$$K_1 = z_2^2/z_3, \quad (6.1)$$

$$K_2 = (z_2z_1)/z_5, \quad (6.2)$$

$$K_3 = (z_3z_1)/(z_2z_5), \quad (6.3)$$

$$K_4 = z_4/z_1^2. \quad (6.4)$$

According to [11-12], equilibrium constants K_1, K_3 and K_4 can be found and calculated.

It could be easily seen that $K_3 = K_2/K_1$ which means that one of first three equations is not independent; due to this (6.3) will not be considered anymore.

According to (4), balance equations for each element C, H, O can be derived:

$$\text{C:} \quad 1 = z_2 + z_3 + z_4, \quad (7.1)$$

$$\text{O:} \quad q + w + 2m = z_2 + 2z_3 + z_5, \quad (7.2)$$

$$\text{H:} \quad z + 2w = 2z_1 + 4z_4 + 2z_5. \quad (7.3)$$

C. Heat balance

It is assumed, as in literature [9-16], that the gasifier is isolated from the ambient. Therefore, gasification is an adiabatic process which means that enthalpy of reactants is the same as enthalpy of products. That is given in heat balance law:

$$\text{enthalpy of reactants} = \text{enthalpy of products} \quad (8.1)$$

According to (8.1) and (4), heat balance can be expressed as follows:

$$h_{f, \text{Biochar}}^0 + w(h_{f, H_2O}^0 + h_{vap}) + mh_{f, O_2}^0 + mc_{pO_2}(T_{200C} - T_{ambient}) = z_1h_{f, H_2}^0 + z_2h_{f, CO}^0 + z_3h_{f, CO_2}^0 + z_4h_{f, CH_4}^0 + z_5h_{f, H_2O}^0 + \Delta T(z_1c_{pH_2} + z_2c_{pCO} + z_3c_{pCO_2} + z_4c_{pCH_4} + z_5c_{pH_2O}) \quad (8.2)$$

where:

$h_{f,i}^0$ - standard enthalpy of formation for different components [J/kg]

h_{vap} - enthalpy of vaporization of water

c_{pi} - specific heat for different chemical substances [J/(kg K)]

$$\Delta T = T_{gasification} - T_{ambient}$$

As temperature in the gasifier (gasification) and ambient temperature are known variables, enthalpies can be determined. Standard enthalpy of biochar formation is about 26 MJ/kg [17]. Standard enthalpies of formation of other components can be easily found [12]. Oxygen as an oxidizer is preheated to 200°C [7]. Specific heat temperature dependance can be also found [10] and used which makes (8.2) to be the seventh equation of the nonlinear system with seven unknown variables: (6.1), (6.2), (6.4), (7.1), (7.2), (7.3), (8.2). This system can be solved and molar rates of each component with respect to the biochar input can be found.

IV. ANALYSIS OF WATER GAS SHIFT PROCESS

Equilibrium constants of reactions in the water gas shift reactor (this time noted as K_5) can be expressed as:

$$K_5 = (Y_{CO_2} * Y_{H_2}) / (Y_{CO} * Y_{H_2O}) \quad (9)$$

where with 'Y' a mole fraction of the corresponding component is given. The following definitions are used [18-19]:

$$Y_i = n_i/n = (n_{i0} + v_i\varepsilon) / (n_0 + v\varepsilon) \quad (10)$$

where:

n_i is the number of moles of the component i in the reaction

n is the total number of moles in the reaction

n_{i0} is the initial number of moles of the component i prior to the reaction

v_i is the stoichiometric number of the component i

v is the total stoichiometric number of the reaction

$$v = \sum_i v_i$$

ε is the reaction coordinate (that shows extent of reaction).

Accordingly, mole fraction of each substance is given as:

$$Y_{CO} = (n_{CO0} - \varepsilon) / (n_{CO0} + n_{H_2O0} + n_{CO_20} + n_{H_20}), \quad (11.1)$$

$$Y_{H_2O} = (n_{H_2O0} - \varepsilon) / (n_{CO0} + n_{H_2O0} + n_{CO_20} + n_{H_20}), \quad (11.2)$$

$$Y_{CO_2} = (n_{CO_20} + \varepsilon) / (n_{CO0} + n_{H_2O0} + n_{CO_20} + n_{H_20}), \quad (11.3)$$

$$Y_{H_2} = (n_{H_20} + \varepsilon) / (n_{CO0} + n_{H_2O0} + n_{CO_20} + n_{H_20}). \quad (11.4)$$

Equations (9), (11.1), (11.2), (11.3), (11.4) make a system of five equations with six unknown variables:

$$Y_{CO}, Y_{H_2O}, Y_{CO_2}, Y_{H_2}, \varepsilon, n_{H_2O}.$$

Total sum of molar fractions is always equal 1, so this equation is also added to the system:

$$Y_{CO} + Y_{H_2O} + Y_{CO_2} + Y_{H_2} = 1. \quad (11.5)$$

Now, a system of six unknown variables can be solved and molar fractions can be obtained.

To obtain lower temperature in water gas shift (WGS) reactor, syngas from gasifier should be cooled down. It could be done by heat exchanger in a way that syngas heat is used for heating of water supply of vessel. Due to this, no external heat is needed for this reaction.

V. ELECTROLYSIS

Well known dynamics during electrolysis are used in this work.

Hydrogen production dynamics can be expressed:

$$\frac{d n_{H_2-electrolyzer}}{dt} = \frac{P \cdot \eta_{el}}{E} \quad (12)$$

where:

P is electrical power of the electrolyzer,

η_{el} is the electrolyzer efficiency,

E is energy needed for electrolysis of a mole of liquid water.

Dynamics of water consumption needed for supply of electrolyzer is the same as the dynamics of hydrogen production:

$$\frac{d n_{H_2O-supply}}{dt} = \frac{P \cdot \eta_{el}}{E} \quad (13)$$

Dynamics of the obtained oxygen is:

$$\frac{d n_{O_2}}{dt} = \frac{P \cdot \eta_{el}}{2 E} \quad (14)$$

VI. ANALYSIS OF METHANATION PROCESS

Biological methanation is a process of methane production and is a key process in a P2G plant. This process takes place in the methanation reactor in which an aquatic suspension with microorganisms is formed to enable methane production. In biological methanation reactor, each feedstock gas is firstly dissolved in water and then chemical reactions for methane production take place. Solubility of gases, especially solubility of H_2 , is usually a bottleneck in this process. So called gas-liquid mass transfer rate depends on technological details.

A. Mass balance

In the methanation reactor vessel chemical reaction of methanation occurs by using microorganisms in an aqueous solution. Solution of input gases into liquid precedes it. Only gases dissolved in the aqueous solution contribute to methane production. To make an adequate mathematical model, mass balance law is used for both gas and liquid phases [20].

Mass balance law given in (1) can be applied for H_2 and CO_2 in the gas phase:

$$r.c. = \text{input} - 0 + 0 - \text{masstransfer}(\text{gas} \rightarrow \text{liquid}). \quad (15.1)$$

For H_2 and CO_2 in liquid phase:

$$r.c. = 0 - 0 + \text{masstransfer}(\text{gas} \rightarrow \text{liquid}) - \text{methanation}. \quad (15.2)$$

For H_2 in the gas phase there are two inputs, one from the hydrogen storage and another from the syngas. Supply from

the syngas is actually the supply from the reactor in which water gas shift reaction occurs, but due to simplification we call that supply "from syngas".

The output or consumption is the hydrogen transfer from gas to liquid phase:

$$\frac{d n_{H_2g}}{dt} = \frac{d n_{H_2g}(\text{from } H_2 \text{ storage})}{dt} + \frac{d n_{H_2g}(\text{from syngas})}{dt} - \frac{d n_{H_2g}(\text{gas} \rightarrow \text{liquid})}{dt} \quad (16.1)$$

For CO_2 in the gas phase the input is from syngas and the output/consumption is its transfer from gas to liquid phase:

$$\frac{d n_{CO_2g}}{dt} = \frac{d n_{CO_2g}(\text{from syngas})}{dt} - \frac{d n_{CO_2g}(\text{gas} \rightarrow \text{liquid})}{dt} \quad (16.2)$$

For H_2 and CO_2 in the liquid phase the inputs are transferred moles from the gas phase, and their consumptions are due to the methanation reaction:

$$\frac{d n_{H_2l}}{dt} = \frac{d n_{H_2g}(\text{gas} \rightarrow \text{liquid})}{dt} - \frac{d n_{H_2}(\text{methanation})}{dt} \quad (17.1)$$

$$\frac{d n_{CO_2l}}{dt} = \frac{d n_{CO_2g}(\text{gas} \rightarrow \text{liquid})}{dt} - \frac{d n_{CO_2}(\text{methanation})}{dt} \quad (17.2)$$

The production of CH_4 is from the methanation reaction:

$$\frac{d n_{CH_4}}{dt} = \frac{d n_{CH_4}(\text{methanation})}{dt} \quad (17.3)$$

In (16), (17) n is the number of moles. Subscripts "g" and "l" stand for gas and liquid phases, respectively.

B. Gas to liquid transfer

Generally, gas to liquid mass transfer can be noted as [21]:

$$\frac{d n_i(\text{gas} \rightarrow \text{liquid})}{dt} = k_L a_i * (n_{ig} H_i^{cc} - n_{il}) \quad (18.1)$$

where:

n_{ig} – number of moles of substance „i“ in the gas phase

n_{il} – number of moles of substance „i“ in the liquid phase

$k_L a_i$ – gas to liquid mass transfer rate for substance „i“

H_i^{cc} – Henry's law solubility constant based on concentrations ratio for the substance „i“; can be calculated as: $H_i^{cc} = R * T * H_i^{cp}$, H_i^{cp} is Henry's solubility constant based on concentration to pressure ratio; R is the gas constant and T is the temperature in the methanation reactor.

According to (18.1), hydrogen gas to liquid mass transfer is:

$$\frac{d n_{H_2}(\text{gas} \rightarrow \text{liquid})}{dt} = k_L a_{H_2} * (n_{H_2g} H_{H_2}^{cc} - n_{H_2l}) \quad (18.2)$$

Liquid mass transfer rate $k_L a$ is determined by technology and for bubble column reactor literature gives values up to $10 \text{ h}^{-1} / V_r^{-1}$.

where: h – hours and V_r is volume of the methanation reactor vessel which means $k_L a$ is 10 h^{-1} for 1 m^3 of reactor volume [22-23]. According to the literature, dilution factor (for H_2 in water) $H_{H_2}^{cp}$ is about $8 * 10^{-6} \text{ mol}/(\text{m}^3 \text{Pa})$ [24].

Similarly, gas to liquid transfer for carbon dioxide is:

$$\frac{d n_{CO_2}(\text{gas} \rightarrow \text{liquid})}{dt} = k_L a_{CO_2} * (n_{CO_2g} H_{CO_2}^{cc} - n_{CO_2l}) \quad (18.3)$$

The value of $k_L a$ for carbon dioxide can be assumed to be about the same as for hydrogen, while dilution factor for carbon dioxide is according to [25] several hundred times higher than the same one for hydrogen, so it is assumed $H_{CO_2}^{cp} = 35 * 10^{-4} \text{ mol}/(\text{m}^3 \text{Pa})$.

C. Methanation dynamics

Methanation reaction occurs in the methanation reactor, more precisely in its liquid phase:

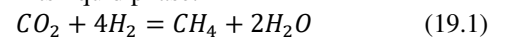

Optimal stoichiometric values of reactants is $H_2 : CO_2 = 4 : 1$.

Production of biomethane is determined by reactant that arises from condition: $\min(4*n_{2l}, n_{CO2l})$. Due to user experience that shows usually hydrogen is in excess, carbon dioxide is to be used in methanation dynamics:

$$\frac{d n_{H_2(\text{methan.})}}{dt} = \text{rate of reaction (19.1)} * 4 * n_{CO2l}, \quad (19.2)$$

$$\frac{d n_{CO_2(\text{methan.})}}{dt} = \text{rate of reaction (19.1)} * n_{CO2l}. \quad (19.3)$$

Production of moles of methane is the same as the consumed moles of carbon dioxide:

$$\frac{d n_{CH_4(\text{methan.})}}{dt} = \text{rate of reaction (19.1)} * n_{CO2l}. \quad (19.4)$$

VII. DYNAMICAL MODELLING OF METHANE PRODUCTION

Dynamics of methanation reactor is analyzed and the proposed control system is given in this section.

A. Dynamical system

Using previously given expressions, dynamical system for gas and liquid phases of H_2 and CO_2 can be obtained. Dynamical system of (16.1), (16.2), (17.1) and (17.2) can be noted using (18.2), (18.3) and (19.2), (19.3):

$$\begin{bmatrix} \frac{d n_{H_2g}}{dt} \\ \frac{d n_{CO_2g}}{dt} \\ \frac{d n_{H_2l}}{dt} \\ \frac{d n_{CO_2l}}{dt} \end{bmatrix} = \begin{bmatrix} -k_L a H_{H_2}^{cc} & 0 & k_L a & 0 \\ 0 & -k_L a H_{CO_2}^{cc} & 0 & k_L a \\ k_L a H_{H_2}^{cc} & 0 & -k_L a & -4 * rr \\ 0 & k_L a H_{CO_2}^{cc} & 0 & -(k_L a + rr) \end{bmatrix} \begin{bmatrix} n_{H_2g} \\ n_{CO_2g} \\ n_{H_2l} \\ n_{CO_2l} \end{bmatrix} + \begin{bmatrix} \frac{d n_{H_2g(\text{from } H_2 \text{ storage})}}{dt} + \frac{d n_{H_2g(\text{from syngas})}}{dt} \\ \frac{d n_{CO_2g(\text{from syngas})}}{dt} \\ 0 \\ 0 \end{bmatrix} \quad (20)$$

Dynamical system given in (20) can be written in a form of a classical linear system:

$$\frac{d x}{dt} = \begin{bmatrix} -k_L a H_{H_2}^{cc} & 0 & k_L a & 0 \\ 0 & -k_L a H_{CO_2}^{cc} & 0 & k_L a \\ k_L a H_{H_2}^{cc} & 0 & -k_L a & -4 * rr \\ 0 & k_L a H_{CO_2}^{cc} & 0 & -(k_L a + rr) \end{bmatrix} x + \begin{bmatrix} 1 & 1 \\ 0 & \alpha \\ 0 & 0 \\ 0 & 0 \end{bmatrix} * \begin{bmatrix} u_1 \\ u_2 \end{bmatrix} \quad (21)$$

where state vector and state matrix are:

$$x = \begin{bmatrix} n_{H_2g} \\ n_{CO_2g} \\ n_{H_2l} \\ n_{CO_2l} \end{bmatrix};$$

$$A = \begin{bmatrix} -k_L a H_{H_2}^{cc} & 0 & k_L a & 0 \\ 0 & -k_L a H_{CO_2}^{cc} & 0 & k_L a \\ k_L a H_{H_2}^{cc} & 0 & -k_L a & -4 * rr \\ 0 & k_L a H_{CO_2}^{cc} & 0 & -(k_L a + rr) \end{bmatrix};$$

and methanation inputs are:

$$u_1 = \frac{d n_{H_2g(\text{from } H_2 \text{ storage})}}{dt};$$

$$u_2 = \frac{d n_{H_2g(\text{from syngas})}}{dt}.$$

Quotient of carbon dioxide and hydrogen in the syngas is given:

$$\alpha = n_{CO_2g(\text{from syngas})} / n_{H_2g(\text{from syngas})}$$

B. System analysis

To make an observability analysis, it is necessary to define an output variable. Number of moles of methane as well as its production rate are measurable. According to (19.4) it is obvious that the amount of produced methane is determined by the amount of carbon dioxide in liquid and that is why x_4 is going to be the output variable y . To make further analysis, system (21) is noted as:

$$\begin{bmatrix} \dot{x}_1 \\ \dot{x}_2 \\ \dot{x}_3 \\ \dot{x}_4 \end{bmatrix} = \begin{bmatrix} -a_1 & 0 & a_2 & 0 \\ 0 & -b_1 & 0 & a_2 \\ a_1 & 0 & -a_2 & c_{14} \\ 0 & b_1 & 0 & d_{14} \end{bmatrix} * \begin{bmatrix} x_1 \\ x_2 \\ x_3 \\ x_4 \end{bmatrix} + \begin{bmatrix} 1 & 1 \\ 0 & \alpha \\ 0 & 0 \\ 0 & 0 \end{bmatrix} * \begin{bmatrix} u_1 \\ u_2 \end{bmatrix} \quad (22.1)$$

$$y = x_4 \quad (22.2)$$

where:

$$a_1 = k_L a H_{H_2}^{cc}; a_2 = k_L a; b_1 = k_L a H_{CO_2}^{cc}$$

$$c_{14} = -4 * rr; d_{14} = -4(k_L a + rr)$$

Only partial observability of the system (22) is assessed. Using x_4 it is possible to observe only variable x_2 .

Dynamics of (22) is used:

$$\dot{x}_2 = -b_1 x_2 + a_2 x_4 + \alpha u_2, \quad (23.1)$$

$$\dot{x}_4 = b_1 x_2 + d_{14} x_4, \quad (23.2)$$

to make a deterministic observer of Luenberger type:

$$\hat{\dot{x}}_2 = -b_1 \hat{x}_2 + a_2 \hat{x}_4 + \alpha u_2 + k_1(x_4 - \hat{x}_4), \quad (24.1)$$

$$\hat{\dot{x}}_4 = b_1 \hat{x}_2 + d_{14} \hat{x}_4 + k_2(x_4 - \hat{x}_4). \quad (24.2)$$

Subtraction (23)-(24) gives error dynamics:

$$\dot{e}_2 = -b_1 e_2 + a_2 e_4 + k_1 e_4 \quad (25.1)$$

$$\dot{e}_4 = b_1 e_2 + d_{14} e_4 + k_2 e_4 \quad (25.2)$$

Using the following Lyapunov function:

$$V = \frac{1}{2}e_2^2 + \frac{1}{2}e_4^2, \quad (26.1)$$

its derivation is obtained:

$$\dot{V} = e_2\dot{e}_2 + e_4\dot{e}_4, \quad (26.2)$$

$$\dot{V} = -b_1e_2^2 + a_2e_2e_4 - k_1e_2e_4 + b_1e_2e_4 + d_{14}e_4^2 + k_2e_4^2. \quad (26.3)$$

When converging coefficients are defined as:

$$k_1 = a_2 + b_1; k_2 > 0$$

stability of the observer can be proved. This is due to b_1 that is always greater than zero and d_{14} that is always less than zero, which both make (26.3) always less than zero and prove asymptotic stability according to Lyapunov.

To maintain constant operating conditions in the methanation reactor it is necessary to maintain the amount of produced methane at the constant nominal rate and to keep the reactor temperature about the same nominal value. Control system will be designed to enable constant methane production as well as constant consumption of all feedstocks. By regulating temperature and flow of the reactor cooling water, temperature and pressure in the reactor can be considered constant during the nominal operation. Reactor pressure is the sum of partial pressures of hydrogen and carbon dioxide. Using the observed value of moles of carbon dioxide and knowing conditions in the reactor, partial pressure of carbon dioxide can be calculated. Partial pressure of hydrogen is calculated by subtraction and accordingly number of moles of hydrogen can be calculated. This value is to be an observed value of the amount of hydrogen. The last unknown variable is x_3 which can be calculated using the observed value of amount of hydrogen, known value x_4 and dynamical equation from the system (22):

$$\dot{\hat{x}}_3 = a_1\hat{x}_1 - a_2\hat{x}_3 + c_{14}x_4 \quad (27)$$

Coefficient a_2 is calculated to be always positive which together with a bounded variable x_4 makes (27) inherently stable.

According to the given analysis, all four state variables can be calculated, which allows a potential control algorithm to use all of them.

C. Control system

Methanation process is controlled indirectly by Power to Gas control system. As shown in Fig. 1, control of the P2G plant is obtained by check valves from hydrogen and oxygen storages. Control of hydrogen storage enables control of hydrogen input to the methanation reactor. Control of oxygen supply makes control of gasification process which is in the same time control of syngas input into the methanation reactor. Controllability of the system (22) with the given methanation inputs is checked to be full. Then, a control system is made as given in Fig. 2. Two control loops are used, the first one for control of ideal ratio of amounts of gases in the liquid for the methanation process and the second one for control of rate of methanation. Control of the ideal ratio is made by two *PI* controllers. The outer *PI 1* compares the ratio to a reference value. The inner one, *PI 2*, makes control of the amount of hydrogen in the gas phase. Namely, although the aim of the loop is to control the molar concentration of hydrogen in the liquid phase, the only way to do it is by increasing its corresponding concentration in the gas phase. According to (21), dynamics of hydrogen in the gas phase is:

$$\frac{dx_1}{dt} = -a_1x_1 + a_2x_3 + u_1 + u_2 \quad (28.1)$$

This can be noted as a linear difference equation of the first order if a novel input value u_a is created. The obtained dynamics is then:

$$\frac{dx_1}{dt} + a_1x_1 = u_a. \quad (28.2)$$

Now, it is easy to make controls of (28.2) in a closed loop. Using u_a and u_2 , the control input u_1 is calculated as:

$$u_1 = u_a - u_2 - a_2x_3 \quad (28.3)$$

In the second control loop, methane production is controlled by *PI 3*.

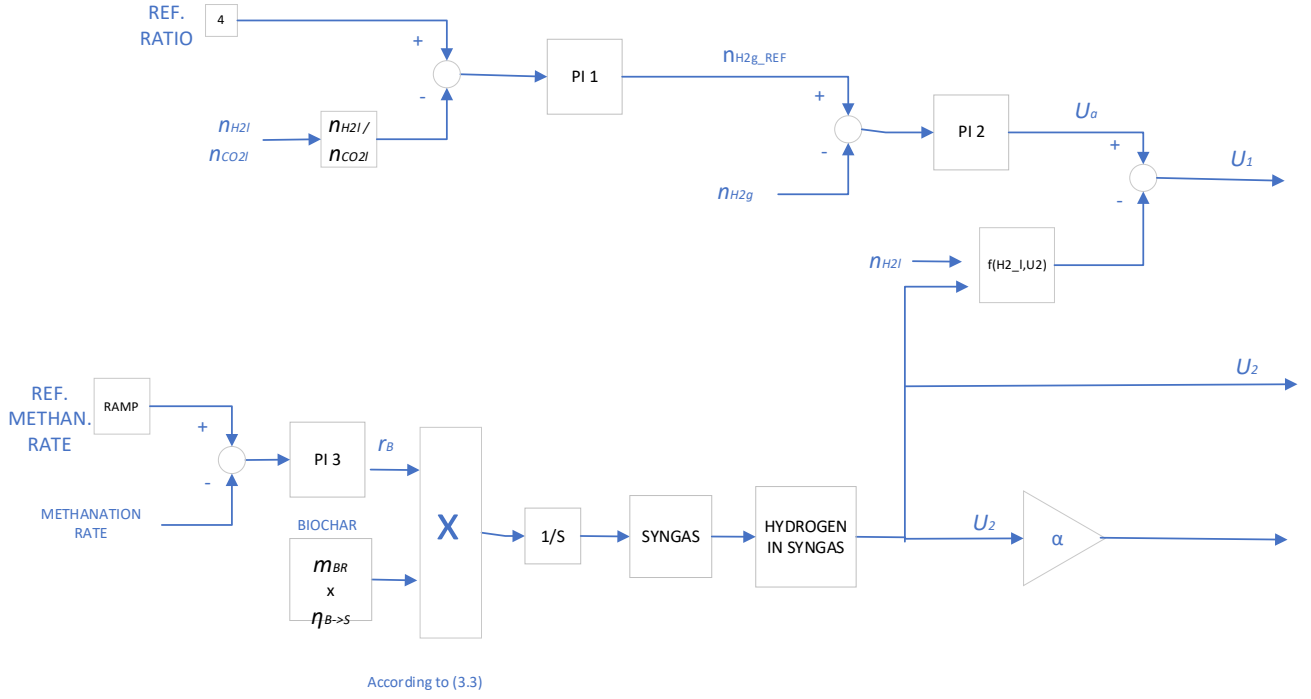

Fig. 2 Structure of the ideal H₂ to CO₂ ratio and methanation rate control system

VIII. SIMULATION

Before simulation experiments are done, parameters of the dynamical system are to be calculated. After the simulation is done, simulation results can be used to make final assessment of consumed energy and feedstock of Power to Gas plant.

A. Parameter calculation

Firstly, calculation of syngas composition according to Section III is done. With the assumed values for moisture and oxygen:

$$w = 0.3; m = 0.2$$

equilibrium of system is obtained at 1400 K, with the following stoichiometric ratio coefficients:

$$z_1 = 1.7; z_2 = 1; z_3 = 0; z_4 = 0.005; z_5 = 0;$$

$$z = 2.8; q = 0.3 .$$

This means that ratio between hydrogen and carbon dioxide $z_1:z_2$ is 1.7:1. This ratio is used in initializing of water gas shift reaction.

Then, water gas shift calculation, according to Section IV, is done. At first, initial numbers of moles is assumed to be

$$n_{CO_0} = 1; n_{H_2_0} = 1.7$$

and after few iterations, equilibrium of system is obtained at 500 K, with the following results:

$$Y_1 = 0.03; Y_2 = 0.03; Y_3 = 0.24; Y_4 = 0.7$$

$$\varepsilon = 0.7; n_{H_2O_0} = 1 .$$

Ratio of output gases (carbon dioxide to hydrogen ratio - α) is equal to Y_3/Y_4 what is approximately 1/3.

Consumption of the water supply during WGS is determined by the initial number of moles of water obtained by this calculation.

Parameters of the system (21) are to be calculated. To make it possible some values of methanation reactor are to be assumed. It is assumed that reactor volume is 100 m³, its temperature is 60°C and its pressure does not exceed 10 bars. At first dimensionless Henry solubility constants for hydrogen and carbon dioxide respectively are calculated:

$$H_{H_2}^{cc} = R * T * H_{H_2}^{cp} = 22 * 10^{-3} \quad (29.1)$$

$$H_{CO_2}^{cc} = R * T * H_{CO_2}^{cp} = 9673 * 10^{-3} \quad (29.2)$$

Gas to liquid mass transfer rate is then calculated to be:

$$k_L a = \frac{10 m^{-3} * 100 m^3}{3600 s} = \frac{1000}{3600} s^{-1} \quad (30)$$

From the user experience, methanation production rate is generally known to be 10 Nm³ per 1 m³ of reactor during one hour of nominal operation. At first, scaling of this value with reactor parameters is done. Then, few experimental simulations are done to obtain similar value of produced methane. Finally, value of the methane production rate is found to be 10 mol/s which is set as a reference value.

At last, value of the reaction rate rr (19.1) is to be determined. It is known that its value is to be high enough not to make a bottleneck of the process; that means its value is higher than $H_{H_2}^{cc}$. Also, for the same gas inputs, increasing its value will decrease amounts of gases in the reactor. This means that reaction rate is determined by pressure constraint. It is assumed that gases encompass about half of the reactor volume. Accordingly, it could be calculated that allowed

amounts of gases in gas phase is limited to about 20 000 moles. After few simulations it is found that reaction rate value:

$$rr = 0.5 \text{ s}^{-1} \quad (31)$$

results in total amount of gases in gas phase well below the stated limit.

Simulation is initialized to start in the vicinity of a known nominal point. Amount of hydrogen in the gas phase is set to 8000 moles and all other amounts are set to zero. Three hours of operation are simulated.

B. Results

Dynamics of all state variables are given. In Fig. 3 response of the quantity of hydrogen in the gas phase is given. Its final value is about 10 000 moles.

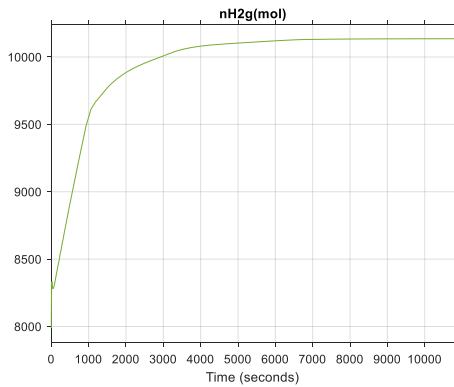

Fig. 3 Quantity of H₂ in the gas phase

In Fig.4 response of the hydrogen quantity in the liquid phase is given. High difference between the values of hydrogen in gas and liquid phases is due to low solubility of hydrogen.

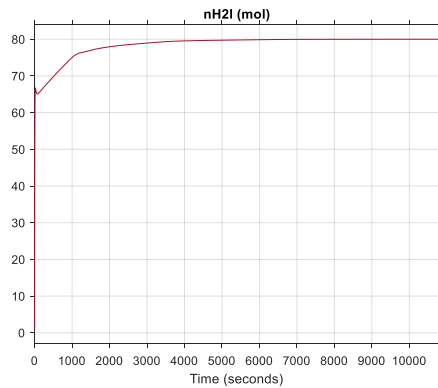

Fig. 4 Quantity of H₂ in the liquid phase

In Fig. 5 the responses of carbon dioxide quantities in the gas and liquid phases are given. It is interesting to notice that its amount in the gas phase is lower than the amount in the liquid phase. This is due to higher solubility of carbon dioxide than the *rr* used in this simulation.

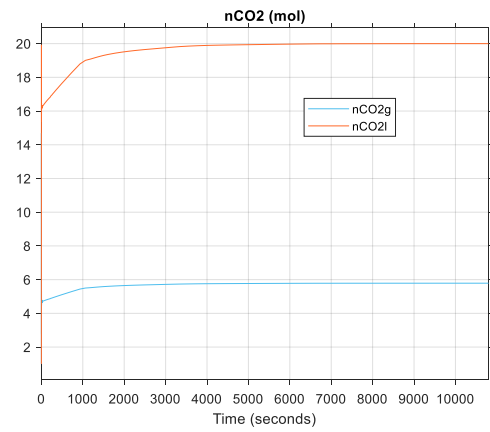

Fig. 5 Quantities of CO₂ in gas and liquid phases

A small error during ratio control exists only at the starting point as it is shown in Fig. 6.

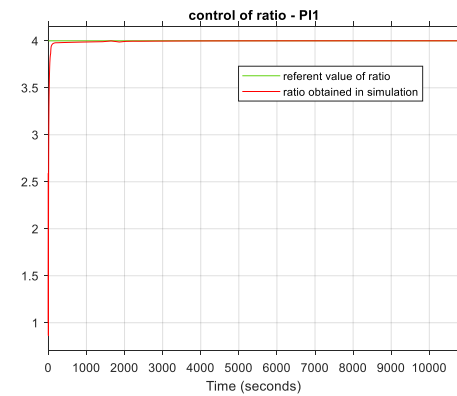

Fig. 6 Control of the ratio

Rate of methane production is given in Fig. 7.

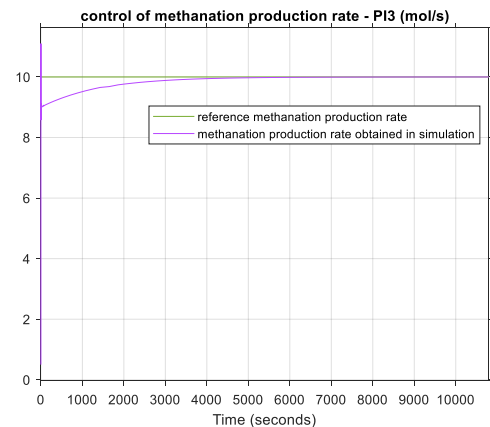

Fig. 7 Rate of CH₄ production

Finally, as is given in Fig. 8 and Fig. 9, input variables show acceptable and easy obtainable dynamics.

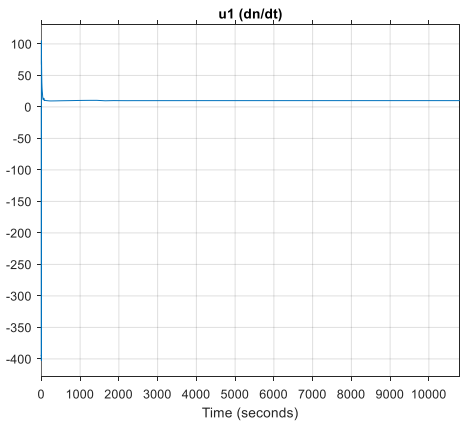

Fig. 8 Dynamic behaviour of input u_1

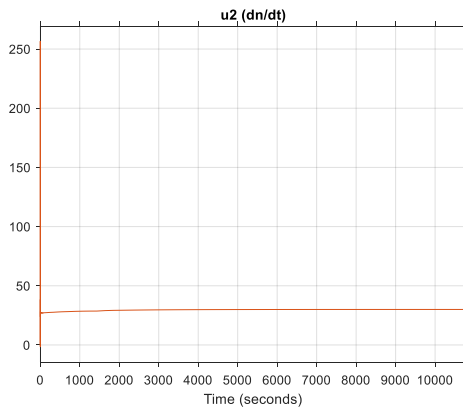

Fig. 9 Dynamic behaviour of input u_2

C. Assesment of Power to Gas consumption

By integration of the methanation input u_1 , amount of hydrogen from the hydrogen storage can be obtained. Using (12), electrical power as well as energy needed for P2G electrolyzer operation can be then calculated.

Using (13), amount of water supply during electrolysis can also be calculated. Summing it with water amount needed for the water gas shift reaction, total amount of P2G demineralized water supply can be obtained.

By integration of the methanation input u_2 , amount of hydrogen from (water gas) syngas can be obtained. Knowing α ratio, amount of carbon dioxide from (water gas) syngas can be also obtained. Summing both, amount of syngas can be calculated and using (3.3) and (2.3) mass of biochar needed for P2G operation can be also obtained.

IX. CONCLUSIONS

Based on the derived control synthesis procedures for a P2G plant the production of methane as well as consumptions of electrical energy and all feedstock material (biochar and supply water) in it can be assessed as functions of time. Performance of the proposed P2G plant is fast and precise. If monetary values of produced and consumed goods are taken into consideration, this model can be the basis for techno-economic studies. Except from that, the proposed method gives a modelling framework for optimization of the plant assembly parts such as the volumes of hydrogen storage, gasifier and methanation reactor.

X. DECLARATIONS

A. Funding

This work was supported by the European Union from the European Regional Development Fund through Interreg Danube Transnational Programme as part of the project DanuP-2-Gas: Innovative model to drive energy security and diversity in the Danube Region via combination of bioenergy with surplus renewable energy (Project no. DTP3-745-3.2).

B. Conflicts of interest

The authors declare that they have no known competing financial interests or personal relationships that could have appeared to influence the work reported in this paper.

C. Availability of data and material

All relevant data are within the paper.

D. Code availability

P2G model used in simulation could be given as supplementary document.

E. Authors Contribution

Marijo Šundrica: Conceptualization, methodology, software, investigation, original draft. Mario Vašak: Methodology, results validation. Joseph Maroušek: Introduction, terms clarification. Tim Bieringer: Conceptualization, user experience, overall validation. All authors have read and approved the manuscript.

REFERENCES

- [1] Xing X, Lin J, Song Y, Zhou Y, Mu S, Hu Q (2018) Modelling and operation of the power-to-gas system for renewables integration: A Review. CSEE Journal of Power and Energy Systems Vol. 4 No. 2: 168–178. <https://doi.org/10.17775/CSEEJPES.2018.00260>
- [2] Ridjan I, Hansen K, Sorknaes P, Xu J, Connolly D, Mathiesen BV (2016) The role of electrolyzers in energy system: Energy markets, grid stabilization and transport fuels. Department of Development and Planning, Aalborg University
- [3] Lambert M (2018) Power-to-Gas: Linking electricity and gas in a decarbonizing world?. Oxford Energy Insight: 39.
- [4] Perna A, Moretti L, Ficco G, Spazzafumo G, Canale L, M. Dell'Isola M (2020) SNG generation via power to gas technology: plant design and annual performance assessment. MDPI Applied Sciences 10(23) 8443:1–22. <https://doi.org/10.3390/app10238443>
- [5] Yang J, Cheng Y, Kang C, Xia Q (2019) Modeling and Operation Mechanism of Combines P2G and Gas-Fired Plant With CO₂ Recycling. IEEE Transactions on smart grid Vol.10 No.1:1111-1121. <https://doi.org/10.1109/TSG.2018.2849619>
- [6] Simonis B, Newborough M (2017) Sizing and operating power-to-gas systems to absorb excess renewable electricity. ELSEVIER International Journal of Hydrogen Energy 42: 21635–21647. <https://doi.org/10.1016/j.ijhydene.2017.07.121>
- [7] Kremling M, Briesmeister L, Gaderer M, Fendt S (2017) Oxygen-blown entrained flow gasification of biomass: impact of fuel parameters and oxygen stoichiometric ratio. Energy Fuels 31 4: 3949-3959. <https://doi.org/10.1021/acs.energyfuels.6b02949>
- [8] Venkata Ramanan M, Lakshmanan E, Sethumadhavan R, Renganarayanan S (2008) Performance prediction and validation of equilibrium modeling for gasification of cashew nut shell char. Brazilian Journal of Chemical Engineering 25(3): 558-601 <https://doi.org/10.1590/S0104-66322008000300016>

- [9] Ferreira S, Monteiro E, Brito P, Vilarinho C (2019) A holistic review on biomass gasification modified equilibrium models. *Energies* 2019, 12(1) 160. <https://doi.org/10.3390/en12010160>
- [10] Zhang X, Zhou Y, Jia X, Feng Y, Dang Q (2020) Multi-criteria optimization of a biomass-based hydrogen production system integrated with organic Rankine cycle. *Frontiers in Energy Research* 8: 584215. <https://doi.org/10.3389/fenrg.2020.584215>
- [11] Rupesh S, Muraleedharan C, Arun P (2015) A comparative study on gaseous fuel generation capability of biomass materials by thermo-chemical gasification using stoichiometric quasi-steady-state model. *International Journal of Energy and Environmental Engineering* 6: 375-384. <https://doi.org/10.1007/s40095-015-0182-0>
- [12] Zainal ZA, Ali R, Lean CH, Seetharamu KN (2001) Prediction of performance of a downdraft gasifier using equilibrium modeling for different biomass materials. *Energy Conversion and Management* 42 (12): 1499-1515. [https://doi.org/10.1016/S0196-8904\(00\)00078-9](https://doi.org/10.1016/S0196-8904(00)00078-9)
- [13] Lundberg L, Tchoffor PA, Johansson R, Pallares D (2015) Determination of kinetic parameters for gasification of biomass char using bubbling fluidized bed reactor. 22. *FCB*, June 2015: 456-464.
- [14] Nowicki L, Siuta D, Markowski M (2020) Carbon dioxide gasification kinetics of char from rapeseed oil press cake” *Energies* 2020, 13(9):2318. <https://doi.org/10.3390/en13092318>
- [15] Xu Q, Pang S, Levi T (2011) Reaction kinetics and producer gas composition of steam gasification of coal and biomass blend chars, part 2: Mathematical modelling and model validation. *Elsevier Chemical Engineering Science* 66 (10): 2232-2240. <https://doi.org/10.1016/j.ces.2011.02.054>
- [16] Raza SS, Janajreh I, Ghenai C (2012) Thermodynamics equilibrium analysis within the entrained flow gasifier environment. *Int. J. of Thermal & Environmental Engineering* Volume 4, No. 1: 47-54. <https://doi.org/10.5383/ijtee.04.01.007>
- [17] Dabrowska M, Jaworek M, Swietochowski A, Lisowski A (2017) Valuable energy of biochar from agricultural and forest waste streams. *Proceedings of the 8th International Scientific Conference Rural Development*. <https://doi.org/10.15544/RD.2017.011>
- [18] Ngo SI, Nguyen TDB, Lim Y-I, Song B-H, Lee U-D., Choi Y-T, Song J-H (2011) Performance evaluation for dual circulating fluidized-bed steam gasifier of biomass using quasi-equilibrium three-stage gasification model. *Elsevier Applied Energy* 88 (12): 5208-5220. <https://doi.org/10.1016/j.apenergy.2011.07.046>
- [19] Smith JM, VanNess HC, Abbott MM (2015) *Introduction to chemical engineering thermodynamics*. Mc Graw-Hill, New York
- [20] Seyednejadian S, Rauch R, Bensaid S, Hofbauer H, Weber G, Saracco G (2018) Power to fuels: Dynamic modeling of a slurry bubble column reactor in lab-scale for Fisher Tropsh synthesis under variable load of synthesis gas. *Applied Sciences* 2018, 8(4):514. <https://doi.org/10.3390/app8040514>
- [21] Lefebvre J (2019) Three-phase CO₂ methanation – Methanation reaction kinetics and transient behavior of a slurry bubble column reactor. PhD Thesis, Karlsruhe Institut für Technologie (KIT)
- [22] Grimalt-Aleman A, Skiadas IV, Gavala HN (2017) Syngas biomethanation: state-of-the-art review and perspectives. *Biofuels, Bioproducts and Biorefining* 12(1): 139-158. <https://doi.org/10.1002/bbb.1826>
- [23] Guiot SR, Cimpoaia R, Navarro SS, Prudhomme A, Filiatrault M (2013) Bio-upgrading of syngas methane. 13th World Congress on Anaerobic Digestion, Spain, June, 2013.
- [24] Sander RE (2014) Compilation of Henry’s law constants, version 3.99. *Atmospheric Chemistry and Physics Discussions* 14 (21): 29615-30521. <https://doi.org/10.5194/acpd-14-29615-2014>
- [25] Bensmann A, Hanke-Rauschenbach R, Heyer R, Kohrs F, Benndorf D, Reichel U, Sundmacher K (2014) Biological methanation of hydrogen within biogas plants: A model-based feasibility study. *Applied Energy* 134: 413-425. <https://doi.org/10.1016/j.apenergy.2014.08.047>