

Performance test on a 5kW SOFC system under high fuel utility with practical syngas feeding

ming xu

National Institute of Clean and Low Carbon Energy

Hanlin Wang

National Institute of Clean and Low Carbon Energy

Mingxian Liu

China energy investment Co Ltd

Jianning Zhao

Ningxia coal industry group

Yuqiong Zhang

china energy investment co ltd

Pingping Li

National Institute of Clean and Low Carbon Energy

Mingliang Shi

china energy investment co ltd

Siqi Gong

National Institute of Clean and Low Carbon Energy

Zhaohuan Zhang

National Institute of Clean and Low Carbon Energy

Chufu Li (✉ chufu.li@chnenergy.com.cn)

Research

Keywords: SOFC, IGFC, gasification, stack tower

DOI: <https://doi.org/10.21203/rs.3.rs-33010/v2>

License:   This work is licensed under a Creative Commons Attribution 4.0 International License.

[Read Full License](#)

Abstract

With increasing demand of green energy supply with high efficiency and low CO₂ emission, Solid oxide fuel cell (SOFC) has been intensively developed in recent years. And the integration of gasification with fuel cell (IGFC) shows potential in large scale power generation to further increase the system efficiency. Reliable design of multi-stacks for large system and long term stability of stacks with practical fuel gas from industrial equipment are the key for commercial application of IGFC. In this work, a test rig of 5kW SOFC system was fabricated using practical syngas from industrial gasifiers as fuel and long term test under high fuel utility was conducted to investigate the system performance. The results show that the maximum steady output power of system is 5700W for hydrogen case and 5660W for syngas case, and the maximum steady electrical efficiency is 61.24% while the fuel utility efficiency is 89.25%. The test lasted for more than 500h as the fuel utility efficiency was larger than 83%. The performances of each stack tower are almost identical at both initial stage and after long term operation. After 500h operation, the performances of stack towers just slight decrease under lower current and almost not change under higher current. Therefore, the results illustrate that the reliability of multi-stacks design and the prospect of SOFC power generation system for further enlarging its application in a MW_{th} demonstration.

Introduction

With increasing demand of green energy supply with high efficiency and low CO₂ emission, solid oxide fuel cell (SOFC) is an attractive choice, thus get more attention of researchers and has been intensively developed in recent years [1]. Its advantages include variety of fuels, high electrical efficiency and full utility of heat, quiet operation and versatility in the electrolyte material [2]. It provides an high electrical efficiency of about 60% in normal operation and up to 90% in combined heat and power operation [3]. It also has the flexibility to be integrated with another power generation source, water heating device and cooling device used in residential homes [4]. To further its application for large scale, the integration of SOFC with gasification using coal or biomass as feedstock shows potential in power generation [5-7]. And it seems a feasible and prospective way for integration gasification with fuel cell (IGFC).

Most of researches on SOFC focus on materials for the development of anode, electrolyte and cathode as well as performance test of cell [8,9]. And different cells have been developed for better chemical stability and electrochemical performance. As the performance of cells improving, SOFC stacks consisting of multi-layer cells should obtain more attention to widen the applications, while not much research work on them. Lim et al. fabricated and characterized an anode-supported flat tubular SOFC stack for intermediate temperature operation and the result show a maximum power of nearly 921W at 750°C using H₂ (fuel utilization ratio=25.2%) as the stability test period is about 200h [10]. Fang et al. conducted durability test and investigated degradation behavior of a 2.5 kW SOFC stack with internal reforming of LNG [11]. They also tested two stacks of different design under high utilization of up to 90% with humidified hydrogen or 10% pre-reformed LNG, and the results found that high fuel utilization could introduce polarization and a high risk of fuel starvation [12]. The fuel utilization ratio is between

64%~80% and mostly about 70% while the feeding fuels of the anode side are H₂ or simulated reformat gas, and the stability test period is more than 5000h under 700°C. Edison R&D center built a 5kW SOFC system and conducted life test for 1500h at fixed power output (1500W) over four start-up/shutdown cycles, and the system power was up to 3000W during the first test sessions. [13].

Researches also have been explored on combine SOFC with gasfication to widen the application in more fields for heat utilization besides electrical supply. Lim et al. constructed a pressurized 5kW class anode-supported planar SOFC power generation system with a pre-former for a fuel cell/gas turbine hybrid system [14]. The results show that the output of the SOFC stack was 4.7kW for the pre-performed gas while the output increased to 5.1kW at 3.5atm (abs.). Modelling of common hybrid configuration of the SOFC-Gas turbine system illustrated a significant efficiency upgrade. The combined SOFC-Gas turbine system produces an electric efficiency up to 50% and better syngas utilization compared to the implementation of each single technology [15]. Subotic et al. discussed the applicability of the SOFC technology for coupling with biomass-gasifier systems, using commercial SOFC single cells of industrial size fueled with different representative producer gas compositions of industrial relevance at two relevant operating temperatures [7]. The results show that feeding SOFC with a producer gas from a downdraft gasifier, with hot gas cleaning operating temperature of 750 °C represents the most favorable setting, considering system integration and the highest fuel utilization.

There are still few commercial SOFC stacks available in market. To build a demonstration of SOFC power generation system in MW class scale, hundreds of stacks should be well assembled and it is important to distribute the fuel gas for each stack in order to prevent fuel starvation. When coupled with gasfication to use practical produce gas as fuel, long term durability of stacks should be tested as most research using simulated produce gas. As there still lack of performance results of multi-stacks SOFC system using syngas as fuel from industrial gasifiers fed with coal, we fabricated a test rig of 5kW SOFC system using practical syngas from industrial gasifier as fuel to explore the feasibility of a MW class IGFC demonstration equipment. As syngas used as fuel for the anode side, it has been reported that it might lead to fast degradation phenomena due to the impurities such as hydrogen sulphide or tars as well as coke deposition [16-19]. Thus an long term test using practical industrial syngas under high fuel utility was conducted to investigate the influence of syngas on the performance of stacks in this work.

Experimental

2.1 Test rig

As shown in Fig.1, a test rig of 5kW class was designed and implemented, which mainly composed of two parts, a fuel gas supply system and a hotbox shown in Fig.2. The fuel gas supply system could provide H₂, syngas, N₂ and stream for the anode of stacks and air for the cathode. The hotbox consists of a heating furnace and 4 SOFC stacks assembled in parallel connection in the heating furnace. The nominal power of the commercial SOFC stack is designed about 1kW for syngas and H₂ as fuel feeding while it is 1.5kW for CH₄ case. The test rig was operated in the Synthesis Oil Plant in Ningmei Coal to

Liquid (CTL) Company in Ningxia province, and all the fuel gases were provided by industrial equipment. For the power generation control of test rig, the current of stacks were adjusted with two ITEC IT8904 electronic loads.

In the hotbox, four SOFC stacks were divided into two groups, i.e. two stack towers, and two stacks of each stack tower shared one gas distributor. For both anode and cathode side, two branches of fuel feeding gas connected with the inlet of each distributor. And the tail gases were also gathered into the outlet of the distributor and flew out of the heating furnace. The heating furnace had four heating walls and the temperature could be controlled by the heating power with the precision of $\pm 1^\circ\text{C}$. The current and power of each stack tower was controlled with a electronic load.

2.2 Test methods

The schematic flowchart of the experimental setup is shown in Fig.3. Hydrogen and syngas from the 4Mt/a CTL industrial equipment are used as fuel gas supplied to the anode side. Practical stream is added for syngas case and its molar flow rate is equal to CO in the syngas to prevent coke deposition. Nitrogen is used as an inert gas for the anode side. The air used as an oxidant for the cathode is also provided by the CTL plant. The flow rates of gases are controlled by mass flow controllers. The purity of hydrogen is 99.9% and the components of syngas are listed as Table 1. For syngas case, syngas has been desulphurized before it enters into stacks.

Table 1 Components of syngas used for the anode side (molar%)

H ₂	CO	N ₂	CH ₄	Ar
61.774	36.711	1.125	0.372	0.018

As the stacks have been reduced before experimental, a mixture of nitrogen and hydrogen is used as shielding gas for the anode side while air is also used for the cathode side at the start up stage after the stacks were assembled. The inlet pressure of the shielding gas and air are regulated with pressure control valves, and the inlet temperature is controlled by pre-heaters. To save energy, the tail gas flowing out of the stacks transfer heat to the feeding gas flowing into the stacks by high temperature heat exchanger. Then the heating furnace is also controlled the heating power to keep the temperature increasing rate of stacks within $30^\circ\text{C}/\text{h}$. As the system temperature increase, the flow rate of cooling water of secondary heat exchanger is regulated to maintain the temperature of tail gas out of the system, and fans are applied to maintain the system pressure. When the temperature of stacks reaches the working temperature, it maintains 1h and the shielding gas shift to fuel gas. As the test goes, the current is increased and more heat would be produced. Thus the flow rate of air is also adapted to keep the system temperature stable. For the stack, most data is for methane case and no data for syngas case. Therefore, test of hydrogen was performed initially and then hydrogen was changed to syngas. In both cases, the furnace was operated at 770°C .

Results And Discussion

3.1 Performance verification of stack towers design

As the power generation system consists of two stack towers and each tower consist of two stacks, the feasibility of stack towers design was firstly identified. As shown in Fig.4, the results of I - V and I - P of multi-stacks illustrate that the average open circuit voltage (OCV) is 62.35V and the voltage decrease to 41.89V when the current increase to 36A. The system power reaches the design value i.e. 5kW when the current is 29A. The consistence between the two stack towers also could be characterized by the data of electronic load data of each stack tower, as shown in Fig.5. The voltage and power of each stack towers under the same current is almost the same all the test range. As shown in Fig.6, area specific resistance (ASR) of the multi-stacks power generation system stabilize at about $0.35\Omega\cdot\text{cm}^2$ as the current density increase up to $200\text{mA}/\text{cm}^2$. The maximum current density is about $350\text{mA}/\text{cm}^2$ and the fuel utility is larger than 90%. Thus, the performance test results of stack towers identify the reliable design of stack towers.

3.2 Performance results of long term test

A long term performance test using hydrogen and syngas as fuel feeding was conducted. The experimental result of hydrogen as fuel feeding is shown in Fig.7. As the fuel flowrate increases, and the output power increases from 3700W to 5700W. The operation data is very stable and few fluctuations appear in the operation. The detailed operation conditions and results of cases would be discussed in following.

The experimental results of syngas as fuel feeding are shown in Fig.8. As the fuel flowrate increases, the output power increases from 4500W to 5600W. The currents of different cases are very stable while there are fluctuations appeared in the output power. The fluctuations in the output power are caused by fluctuations in the feeding stream flowrate as the pressure of stream from the plant is not very stable. The detailed operation conditions and results of cases would be discussed in following.

The long term performance test lasted about 600h and the overview of the results is illustrated in Fig.9. Totally ten cases of different feeding have been conducted, and the operation conditions as well as the results of electrical efficiency E_f and fuel utility efficiency U_f are listed in Table 2. Electrical efficiency E_f is calculated with input heat of fuels Q_{in} and output electric power P_{out} by $E_f = P_{out}/Q_{in}$. And fuel utility efficiency U_f is calculated by equation as following: , in which I is the current and F is Faraday constant as well as x is the fraction of fuel.

At first, hydrogen is used as fuel feeding to start up the generation system at low fuel utility level. When the operation becomes stable, the fuel flow rate is increased and the current accordingly is increased to keep the fuel utility efficiency above 80%. Then the operation at high fuel utility level lasted for 500h. As for the syngas cases, the ratio of H_2/CO was adjusted to investigate its influence on the system performance. As shown in Table 2, the maximum electrical efficiency is up to 61.24% and the according

fuel utility efficiency is 89.25% in steady operation with hydrogen feeding. For syngas case, the maximum electrical efficiency is up to 56.15% and the according fuel utility efficiency is 88.22%. The maximum output power in steady operation is 5700W for hydrogen feeding cases and it is 5660 W for syngas cases with the approximate feeding flowrate, while the electrical efficiency of hydrogen case was about 2% larger than that of syngas case. No obvious influence of H₂/CO ratio has been found in the experiment as the operation time is not long for each case and should be further investigated.

Table 2 Feeding conditions and the according results of E_f and U_f

case	H ₂ flowrate (slm)	Syngas flowrate (slm)	H ₂ /CO ratio	Current (A)	Power (W)	E _f (%)	U _f (%)
1	52	-		80	3700	43.25	59.70
2	40	-		84	3840	58.35	81.49
3	40	-		92	4030	61.24	89.25
4	-	47.5	3.04	108	4560	56.15	88.22
5	-	57.67	3.13	124	5220	52.98	83.43
6	-	60.5	3.13	130	5430	52.53	83.38
7	-	62.5	3.13	136	5630	52.73	84.43
8	-	62	2.53	136	5660	53.11	85.12
9	-	62.75	3.36	136	5660	52.90	84.10
10	61.9	-		136	5700	55.95	85.23

Performance comparison of stack tower1 of initial with after 500h operation is shown in Fig 10. The voltage and power of stack tower1 is slightly decreased at low current after 500h operation compared with that of initial stage, while the performance is almost the same as initial when the current is increased above 50A. The result of stack tower2 shown in Fig.11 illustrates the similar tendency. As shown in Fig.12, comparison of stack tower1 and tower2 after 500h operation shows almost same performance, just slight different when the current is larger than 60A. The results also illustrate the long term stability of stack towers and the whole system.

Conclusions

In this work, a test rig of 5kW SOFC system was fabricated using practical syngas from industrial gasifiers as fuel and long term test under high fuel utility was conducted to investigate the system performance. The results show that the maximum steady output power of system is 5700W for hydrogen case and 5660W for syngas case, and the maximum steady electrical efficiency is 61.24% while the fuel utility efficiency is 89.25%. The test lasted for more than 500h as the fuel utility efficiency larger than 83%. The mean performance of stack towers is better than that of single stack, and the performances of each stack tower are almost identical. After 500h operation, the performances of stack towers just slight

decrease under lower current and almost not change under higher current. Therefore, the results illustrate that the reliability of multi-stacks design and the prospect of SOFC power generation system for further enlarging its application for a MW_{th} demonstration.

Declarations

Acknowledgement

This work is supported by the National Key R&D Program of China (2017YFB0601900). And the authors are grateful to Ningmei CTL company and Synthesis Oil Plant for the active cooperation of providing experimental resource and operation support.

References

1. Choudhury A, Chandra H, Arora A. Application of solid oxide fuel cell technology for power generation –a review. *Renew Sustain Energy Rev* 2013, 20:430–
2. Secanell M, Wishart J, Dobson P. Computational design and optimization of fuel cells and fuel cell systems: a review. *J Power Sources* 2011, 196:3690–
3. Ud DZ, Zainal ZA. Biomass integrated gasification-SOFC systems: technology overview. *Renew Sustain Energy Rev* 2016, 53:1356–
4. Sadeghi M, Chitsaz A, Mahmoudi SMS, Rosen MA. Thermo economic optimization using an evolutionary algorithm of a trigeneration system driven by a solid oxide fuel cell. *Energy* 2015, 89:191–
5. Moosavian SM, Modiri-Delshad M, Rahim NA, Selvaraj J. Imperialistic competition algorithm: novel advanced approach to optimal sizing of hybrid power system. *J Renew Sustain Energy* 2013, 5:31–
6. Radenahmad N, Azad AT, Saghir M, Taweekun J, et al. A review on biomass derived syngas for SOFC based combined heat and power application. *Renew Sustain Energy Rev* 2020, 119:1–18.
7. Subotic V, Baldinelli A, Barelli L, Scharler R, Pongratz G, Hochenauer C, Anca-Couce A. Applicability of the SOFC technology for coupling with biomass-gasifier systems: Short- and long-term experimental study on SOFC performance and degradation behaviour. *Appl Energy* 2019, 113904.
8. Hossain S, Abdalla AM, Jamain SNB, Zaini JH, Azad AK. A review on proton conducting electrolytes for clean energy and intermediate temperature solid oxide fuel cells. *Renew Sustain Energy Rev* 2017, 79:750–764.
9. Radenahmad N, Afif A, Petra PI, Rahman SMH, Eriksson SG, Azad AK. Proton-conducting electrolytes for direct methanol and direct urea fuel cells - a state-of-the-art review. *Renew Sustain Energy Rev* 2016, 57:1347–1358.
10. Lim TH, Park JL, Lee SB, Song RH, Shin DR. Fabrication and operation of a 1kW class anode-supported flat tubular SOFC stack. *Int. J. Hydrogen Energy* 2010, 35: 9687-9692.

11. Fang QP, Blum L, Batfalsky P, Menzler NH, Packbier U, Stolten D. Durability test and degradation behavior of a 2.5kW SOFC stack with internal reforming of LNG. *Int. J. Hydrogen Energy* 2013, 38: 16344-16353.
12. Fang QP, Blum L, Peters R, Peksen M, Batfalsky P, Stolten D. SOFC stack performance under high fuel utilization. *Int. J. Hydrogen Energy* 2015, 40: 1128-1136.
13. Barrera R, Biase SD, Ginocchio S, Bedogni Stefano, Montelatici L. Performance and life time test on a 5kW SOFC system for distributed cogeneration. *Int. J. Hydrogen Energy* 2008, 33: 3193-3196.
14. Lim TH, Song RH, Shin DR, Yang JI, Jung H, Vinke IC, Yang SS. Operating characteristics of a 5kW class anode-supported planar SOFC stack for a fuel cell/gas turbine hybrid system. *Int. J. Hydrogen Energy* 2008, 33: 1076-1083.
15. Bang-Moller C, Rokni M, Elmegaard B. Exergy analysis and optimization of a bio-mass gasification, solid oxide fuel cell and micro gas turbine system. *Energy* 2010, 36:4740-4752.
16. Lebreton M, Delanoue B, Baron E, Ricoul F, Kerihuel A, Subrenat A, et al. Effects of carbon monoxide, carbon dioxide, and methane on nickel/yttria-stabilized zirconia-based solid oxide fuel cells performance for direct coupling with a gasifier. *Int J Hydrogen Energy* 2015, 40:10231–10241.
17. Cavalli A, Kunze M, Aravind PV. Cross-influence of toluene as tar model compound and HCl on Solid Oxide Fuel Cell anodes in Integrated Biomass Gasifier SOFC Systems. *Appl Energy* 2018, 231:1–11.
18. Ricoul F, Subrenat A, Joubert O, La Salle ALG. Electricity production from lignocellulosic biomass by direct coupling of a gasifier and a nickel/yttria-stabilized zirconia-based solid oxide fuel cell: influence of the H₂S content of the syngas onto performances and aging. *J Solid State Electrochem* 2018, 22:2789–2800.
19. Aravind PV, Ouweltjes JP, Woudstra N, Rietveld G. Impact of biomass-derived contaminants on SOFCs with Ni/Gadolinia-doped ceria anodes. *Electrochem Solid-State Lett* 2008, 11:B24–28.

Figures



Figure 1

Photo of the test rig

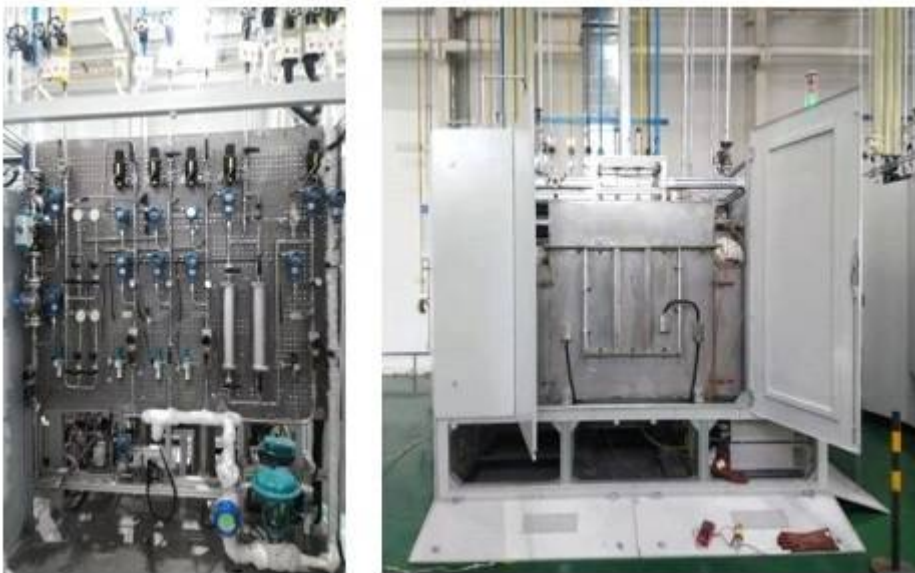

Figure 2

Photos of the fuel gas supply system and the hotbox.

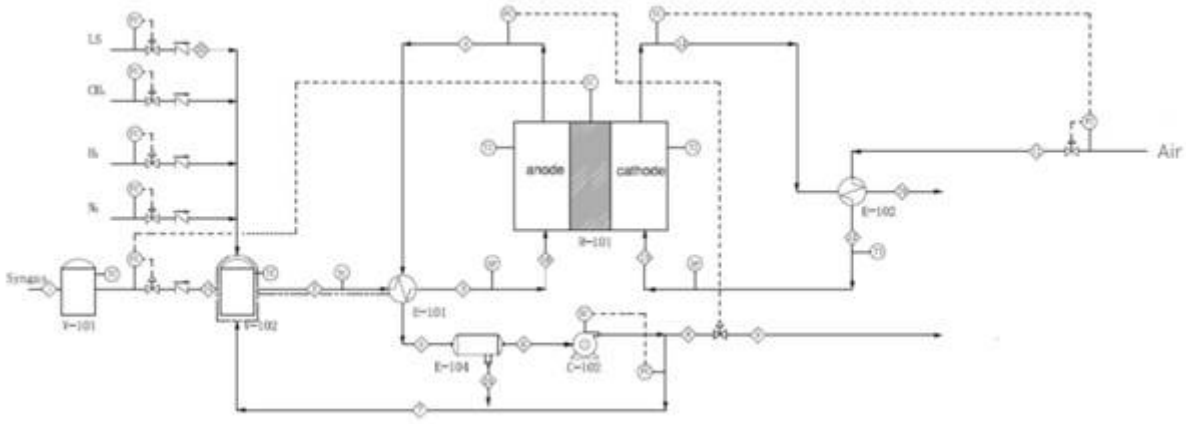

Figure 3

Schematic flowchart of experimental setup

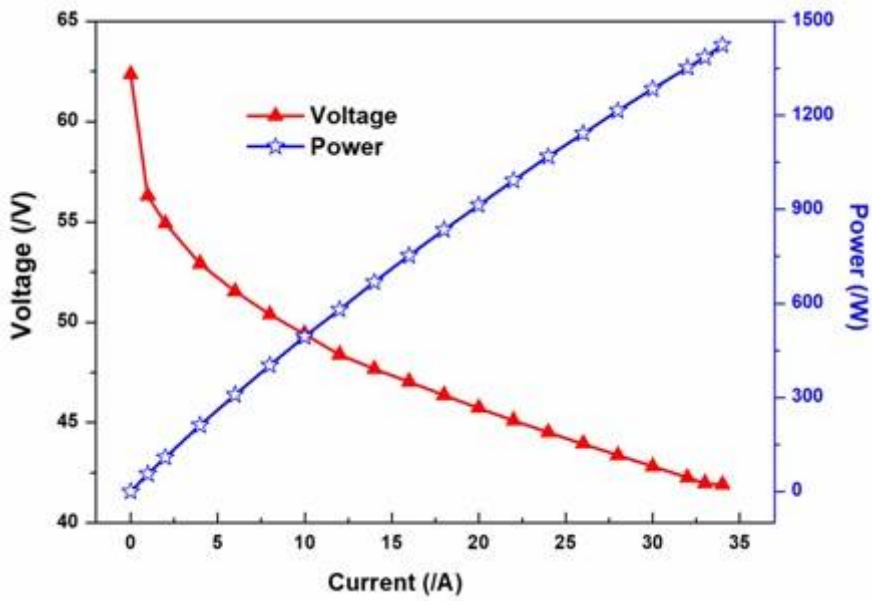

Figure 4

Average performance of multi-stacks

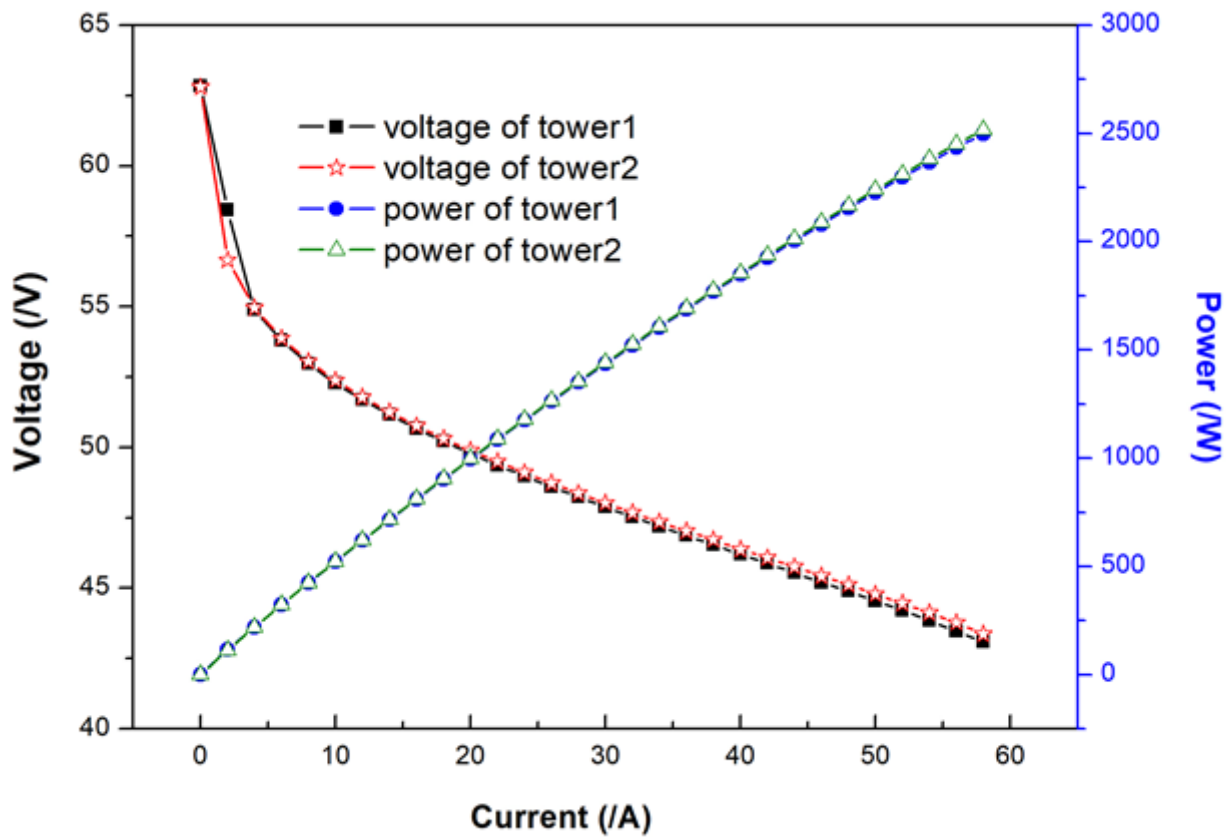

Figure 5

Performance comparison of two stack towers

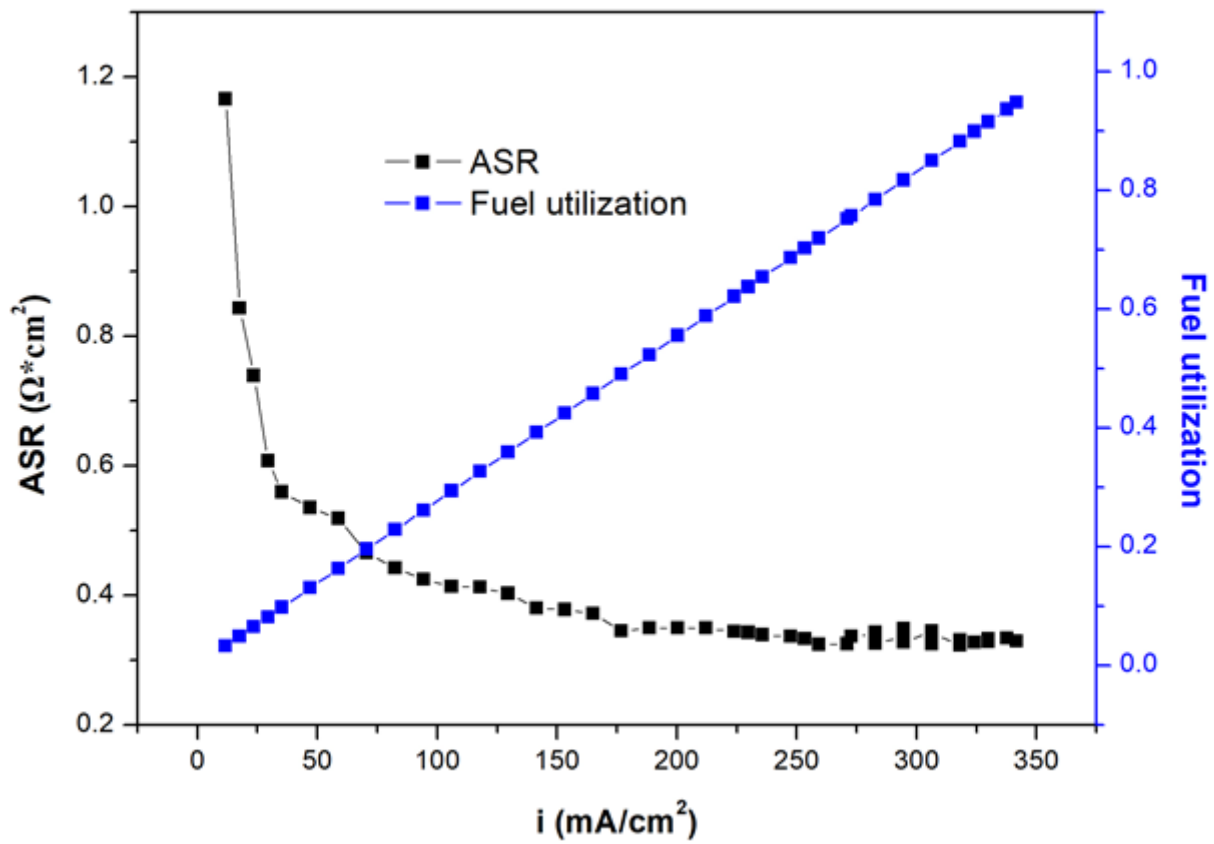

Figure 6

ASR of the test rig

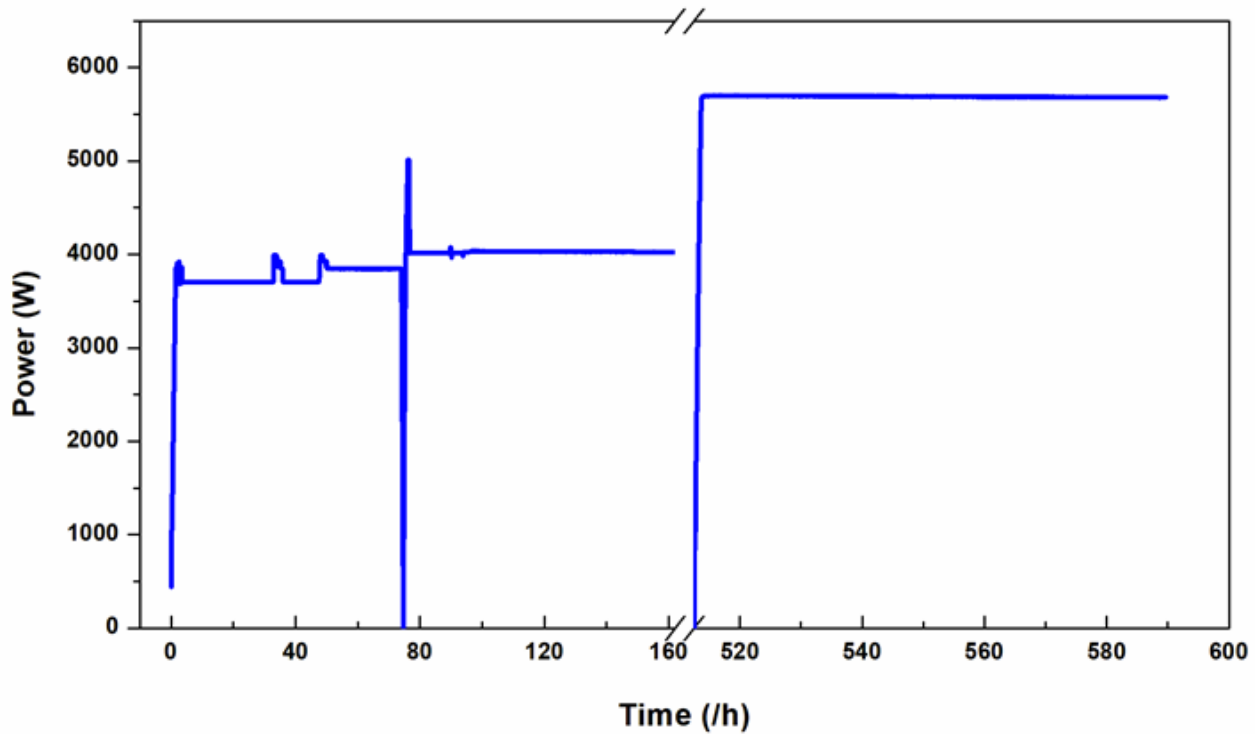

Figure 7

System performance using H2 as fuel feeding

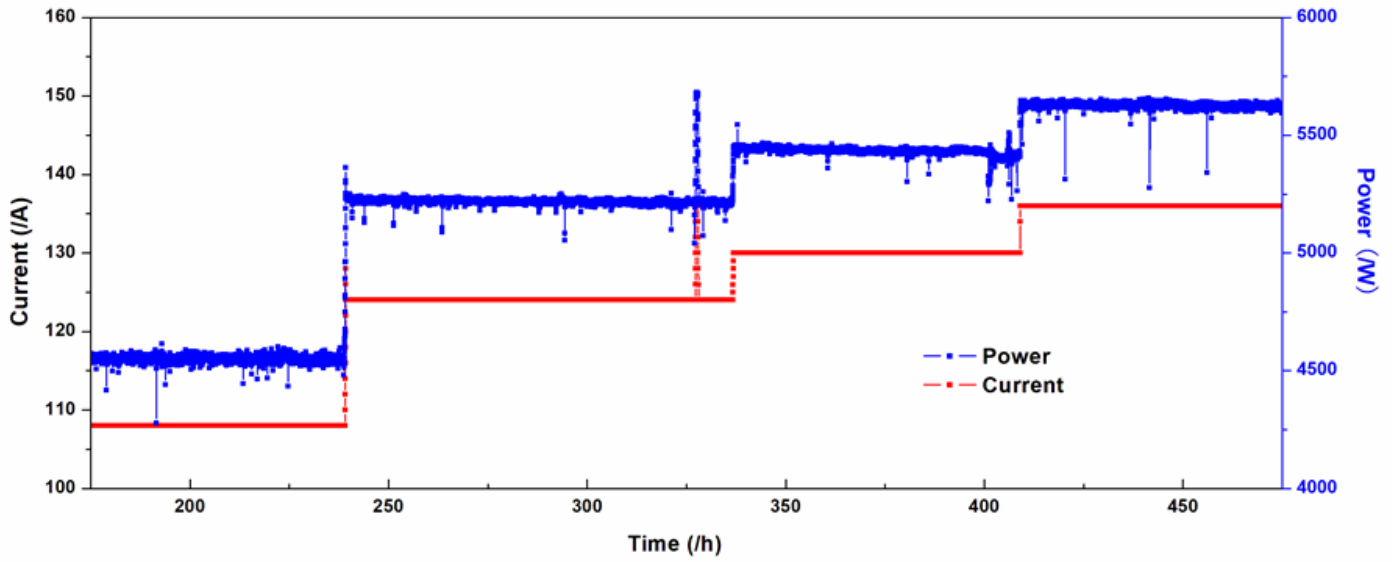

Figure 8

System performance using syngas as fuel feeding

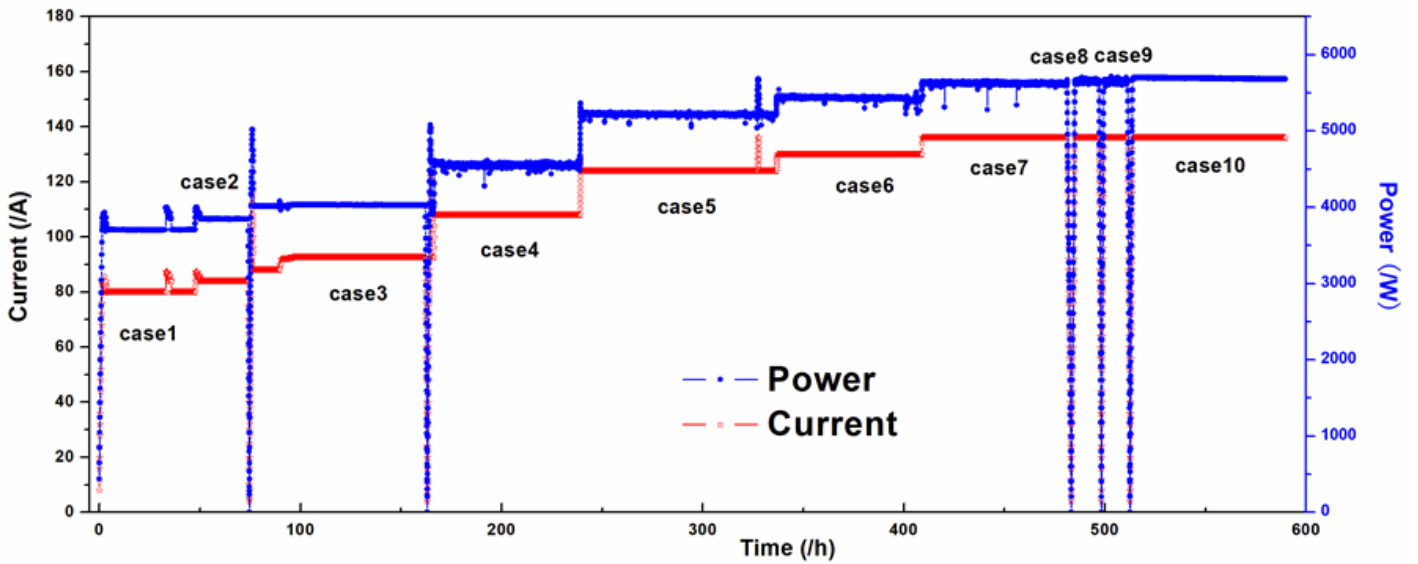

Figure 9

Overview of long term performance test results

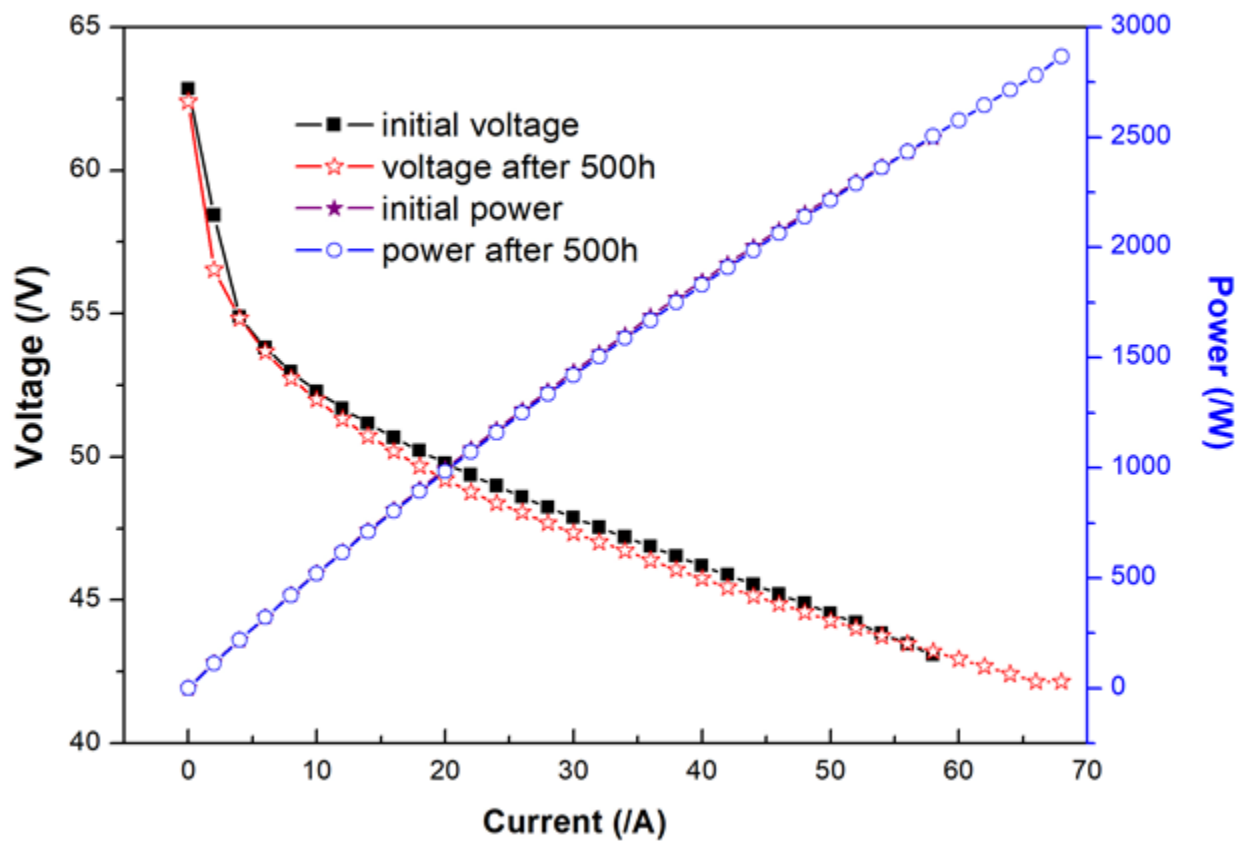

Figure 10

Performance comparison of stack tower1 of initial with after 500h operation

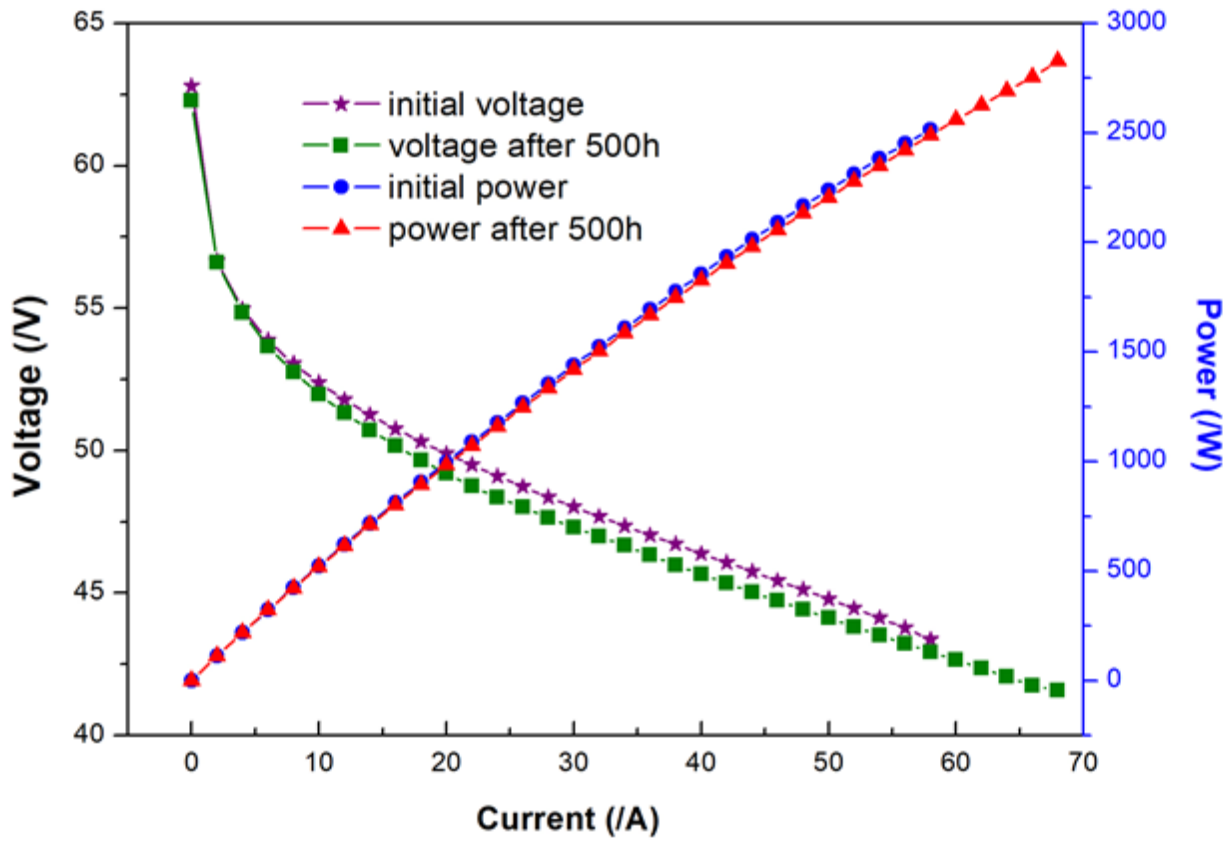

Figure 11

Performance comparison of stack tower2 of initial with after 500h operation

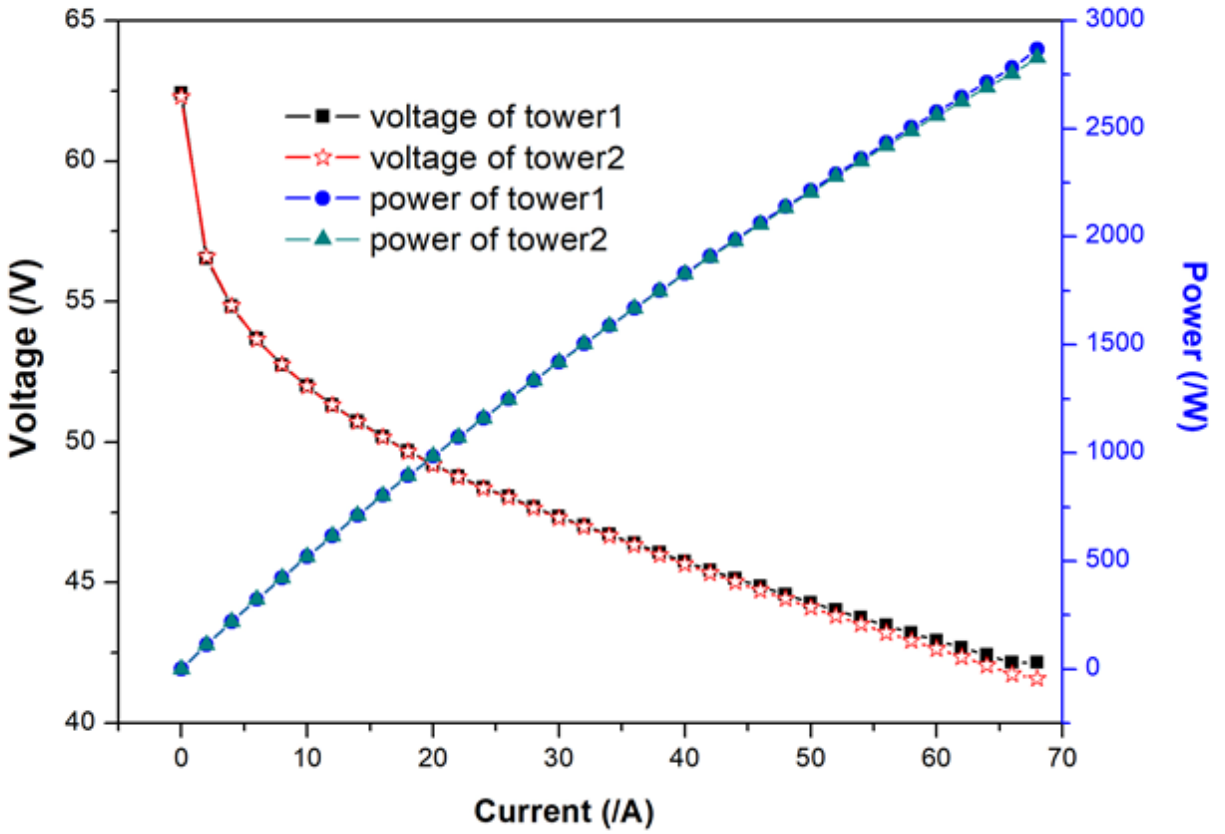

Figure 12

Performance comparison of stack tower1 and tower2 after 500h operation